

## INDEX

<b>1. PRELIMINARY REMARKS</b>	<b>2</b>
<b>2. RESISTANCE TO CHEMICAL AGENTS</b>	<b>2</b>
<b>3. FIXING OF MAGNETIC BAND</b>	<b>2</b>
<b>4. FIXING OF MAGNETIC BAND CSMZ / CSLZ</b>	<b>3</b>
<b>5. SENSOR MOUNTING</b>	<b>3</b>
<b>6. EXTERNAL ZERO REFERENCE MOUNTING</b>	<b>4</b>
<b>7. OUTPUT SIGNALS</b>	<b>4</b>
<b>8. CABLES AND ELECTRICAL CONNECTIONS</b>	<b>4</b>
<b>9. USE AND MAINTENANCE</b>	<b>5</b>
<b>10. WARRANTY TERMS</b>	<b>5</b>
<b>11. DISPOSAL</b>	<b>5</b>
<b>12. TECHNICAL FEATURES - SENSOR</b>	<b>6</b>
<b>13. TECHNICAL FEATURES - BAND</b>	<b>6</b>

**1. PRELIMINARY REMARKS**

Before proceeding with the installation of the product, read carefully the following instructions.

Make connections when power supply is switched off, and batteries (when present) are excluded as well.

During machining, remove any accumulation of swarfs, dusts, etc. that does not allow the free sliding of the movable parts.

The use of a protection cover is recommended to prevent any damage from falling tools or material.

**i** Verify that all the tools used for mounting are strictly demagnetized.

**2. RESISTANCE TO CHEMICAL AGENTS**

LOW-IMPACT AGENTS

Formic acid, lactic acid, formaldehyde 40%, glycerine 93°C, hexane, isooctane, linseed oil, cotton oil, soybean oil, mineral oil.

MEDIUM-IMPACT AGENTS

Acetylene, acetone, acetic acid, oleic acid, stearic acid 70°C, seawater, ammonia, gasoline, ether isopropyl, petroleum, vapour.

STRONG-IMPACT AGENTS

Nitric acid, benzene, dimethylbenzene, tetraethyl furan, nitrobenzene, solvent, toluene, carbon tetrachloride, turpentine, trichloroethylene.

**i** Protect the band from external magnetic fields. Contact with any permanent magnet can irreparably damage the magnetic band.

**3. FIXING OF MAGNETIC BAND**

**i** To guarantee the system accuracy, the magnetic band ① has to be 80 mm longer than the measuring length of the machine (40 mm for each side).

During mounting, the magnetic band has to be adequately centered on the measuring length.

The magnetic band can be fixed on any kind of non-magnetic surface.

For a better protection of the magnetic band from shavings, liquids, powder, etc., we recommend the use of the protective cover PS ②, already equipped with a double-sided adhesive tape ③, or of the aluminium support AP which keeps the magnetic band in the proper position (see the picture in the next page).

The best gluing temperature is between 20 °C and 30 °C. It is not advisable to perform the operation at temperatures below 10 °C.

In case the magnetic band has been stocked at a lower or higher temperature than the machine, it is advisable to wait some hours before gluing it, to stabilize the magnetic band. The adhesion of glued parts is completed after at least 48 hours.

To glue the magnetic band, proceed as follows:

- > Clean carefully the fixing surface from oil, grease or any kind of dirt, using trace-free solvents.
- > Raise few centimeters of the adhesive protection ④ and place the magnetic band properly, exerting a light pressure on the initial adhesive zone.
- > Proceed with the magnetic band fixing, removing progressively the adhesive protection and exerting a uniform pressure. If possible, use a small manual roller.
- > Proceed as above to glue the stainless steel cover tape on the magnetic band, after having accurately cleaned the surface.
- > Use the exceeding part of the protective cover tape for its mechanical fixing and ground connection, by means of screws M3x8 ⑤.

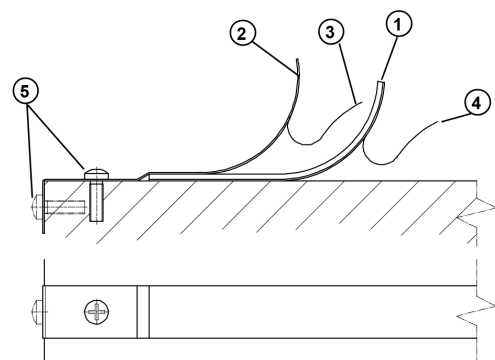

RECOMMENDED FIXING OF SUPPORT AP

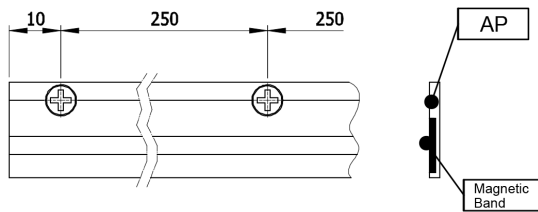

- It is not possible to use the AP support if the magnetic band is already protected by the PS cover.
- It is not possible to apply any protective cover on the magnetic band CSH.

**4. FIXING OF MAGNETIC BAND CSMZ / CSLZ**

The magnetic band CSMZ / CSLZ must be fixed to the machine as the other magnetic bands following the indications provided in section 3.

- For the definition of the zero reference position, the sensor and the magnetic band have to be considered oriented as in the following drawing.

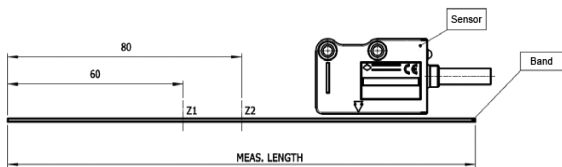

EXAMPLE: CSMZ / CSLZ with zero references at 60 mm and 80 mm from the left.

**5. SENSOR MOUNTING**

- Before turning on the sensor, make sure it is properly mounted.

Use the two M4 threaded holes to fix the magnetic sensor. As an alternative, they can be used as through holes for TCEI M3x18 screws.

The sensor can be mounted in any position, keeping the active side, marked by arrows, towards the surface of the magnetic band.

Once the mechanical mounting has been concluded, manually cover the entire measuring length to make

sure that both the sensor and the cable are able to move without interferences.

Check the respect of the alignment tolerances and the distance between sensor and magnetic band along the entire measuring length. Any positioning error must be corrected.

Spacer blocks or supporting arms should be adequately sized and made rigid to exclude any flexion or vibration that could compromise the system's accuracy.

DIMENSIONS AND DRILLING DIAGRAM

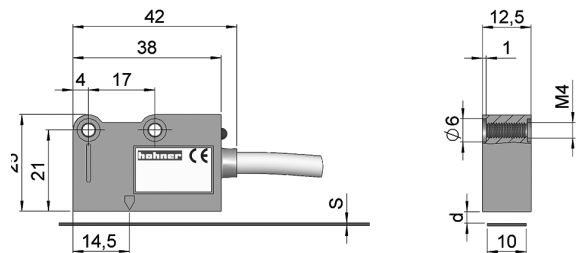

	Magnetic Band	+ PS	+ AP
S (mm)	1.3	1.6	2.1
d (mm) MSH	0.1 ÷ 0.4	-	-
d (mm) MSM	0.2 ÷ 1.4	1.1 MAX	0.6 MAX
d (mm) MSL	0.3 ÷ 4	3.7 MAX	3.2 MAX

	CSMZ / CSLZ	+ PS	+ AP
S (mm)	1.3	1.6	2.1
d (mm) MSM	0.3 ÷ 0.8	0.5 MAX	-
d (mm) MSL	0.35 ÷ 2	1.7 MAX	1.2 MAX

ALIGNMENT TOLERANCES

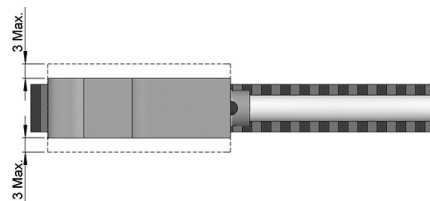
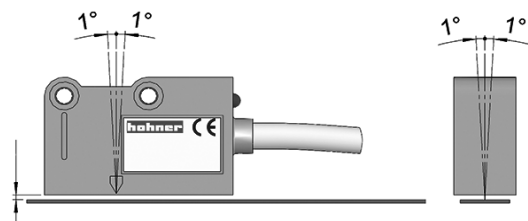

**6. EXTERNAL ZERO REFERENCE MOUNTING**

For the installation of the external zero reference (magnet) proceed as follows:

- > Both the sensor and the magnetic band have to be already fixed to the machine, in their final position.
- > Place the sensor where the zero position is needed.
- > Place the base of the external zero reference parallel to the magnetic band, at a distance D from the sensor (see following drawing). Make the notch, located on the upper part of the reference, correspond to the vertical one on the body of the sensor.
- > Verify that the LED on the sensor turns on in correspondence to the reference index. If this does not occur, move the base of the reference by around 1 mm, until the LED turns on.
- > On the machine, mark the position of M3 holes for fixing the reference.
- > Drill the fixing holes and tighten the reference with 2 socket head screws M3x12, keeping the active part (magnets) toward the sensor. The slots permit a displacement on the magnetic band axis, in order to get an accurate positioning of the reference.

Test the proper functioning in both directions of motion.

**!** Do not put the reference in contact or too close to the magnetic band, since the internal magnets could irreparably damage it.

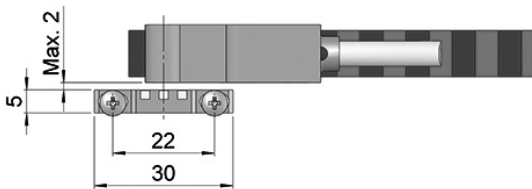
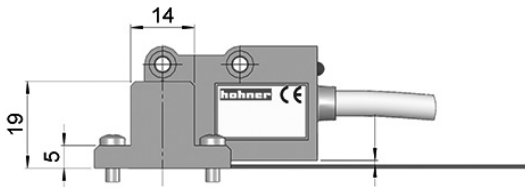

	d (mm)	
MSH (CSH)	-	-
MSM (CSM)	1.5 TYP	2 MAX
MSL (CSL)	1 TYP	2 MAX

d= distance between sensor and external zero reference

**7. OUTPUT SIGNALS**

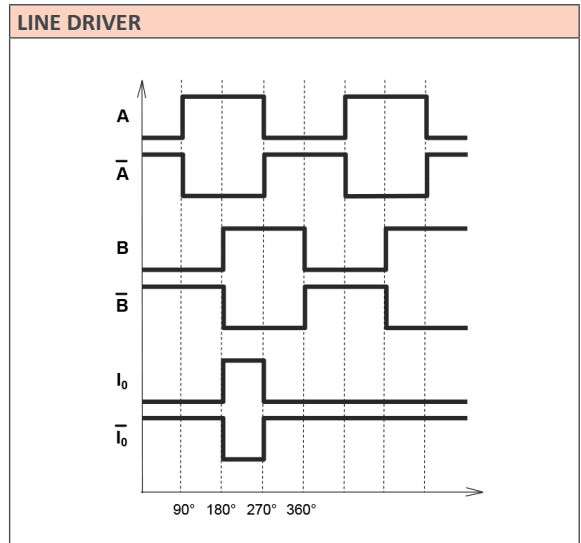

**8. CABLES AND ELECTRICAL CONNECTIONS**

Magnetic sensor can be supplied with different cables, according to customer request. In the standard configuration, the sensor is supplied with a 8-wire cable  $\phi = 6.1$  mm.

- i** For applications where the maximum speed exceeds 1 m/s, it is necessary to use a cable suitable for continuous movements.
- i** The cable's bending radius should not be lower than 90 mm.
- i** During the electrical connection/installation ensure the sensor is switched off, without supply voltage.

The following output signals are available:

SIGNALS	CONDUCTOR COLOR
GND	Blue
VCC	Red
A	Green
B	White
$\tilde{A}$	Orange
$\tilde{B}$	Light-blue
0 (reference)	Brown
$\tilde{0}$	Yellow

The sensor is set up with a LINE DRIVER output. If the reading device cannot read complementary signals, it is necessary to isolate the unused wires one by one. It

is important to note that the connection of the unused wires can damage the sensor and it does not guarantee its immunity from interferences.

Make sure a minimum spacing of 200 mm exists between the cable and any device that may cause electromagnetic interferences (e.g. motors, solenoid valves, inverters).

If interferences are detected, act directly on the source of disturb using EMC filters.

If cable extensions are needed, it is necessary to use shielded cables with a section of at least 0.5 mm<sup>2</sup> for power supply and 0.14 mm<sup>2</sup> for signals.

Verify the correct connection and the continuity of the shield which has to be connected to an earthing node with minimum impedance ( $\approx 0 \Omega$ ).

The sensor is supplied with a standard 2 m-long cable. Longer lengths can be required, considering the following maximum values:

- > L<sub>MAX</sub> = 10 m (sensor cable)
- > L<sub>MAX</sub> = 100 m (2m cable + cable extension)

To balance LINE DRIVER output, the following resistance loads have to be used:

- > 5V R = 120  $\Omega$
- > 12V R = 1.2 k $\Omega$
- > 24V R = 1.2 k $\Omega$

**i** In case of cable extension, it is necessary to guarantee:

- > The electrical connection between the body of the connectors and the cables shield.
- > A minimum power supply voltage of 5 V to the sensor.

## 9. USE AND MAINTENANCE

The magnetic band and the sensor do not require any particular maintenance. A proper installation, complying to the mounting instructions, and the correct use guarantee quality and good operation.

Any discrepancy should be reported to the Manufacturer for repairing or replacement of defective parts.

After maintenance, verify the mounting tolerances and adjust any eventual misalignment.

To preserve the accuracy of the system, do not stress mechanically the magnetic band. The band has to be rolled always in the same way (plastoferrite towards the outside), with a minimum diameter of 250 mm.

## 10. WARRANTY TERMS

Magnetic sensor scale is guaranteed against manufacturing faults for a period of twelve months from the date of purchase. Any repair must take place at the Manufacturer's premises and the Customer shall arrange the delivery of the product, at its own risk and expense.

The Manufacturer is released from any claim against damages due to the non-observance of these instructions or mounting tolerances which causes the annulment of the warranty terms.

The warranty does not provide for repairing and/or replacement of those parts that have been damaged by negligence or misuse, improper installation or maintenance, maintenance performed by unauthorized personnel, transport or any other circumstance that excludes a manufacturing fault of the product.

Similarly, the warranty does not apply if serial numbers or any data identifying the product are cancelled or altered in any way, and if product modifications are introduced without the written authorization of the Manufacturer.

The Manufacturer declines any responsibility for damages to people or properties deriving from the use of the product, including any loss of profit or any other direct, indirect or incidental loss.

## 11. DISPOSAL

**Waste electrical and electronic equipment (WEEE)**  
European Council Directive (2012/19/EU)



The use of the WEEE Symbol indicates that this product may not be treated as household waste.

If this product is disposed correctly, you will help to protect the environment.

For more detailed information about the recycling of this product, please contact your local authority, your household waste disposal service provider or the retailer where you purchased the product.

This information regards only European customers, according to 2012/19/EU European Parliament Directive.

For other countries, please refer to local law requirements.

**12. TECHNICAL FEATURES - SENSOR**

GENERAL FEATURES	
Repeatability	±1 increment
Output signals (A, B, 0)	LINE DRIVER
Max. frequency	300 kHz
Power supply	5...28 VDC ±5%
Current consumption with load	140 mA MAX (VDC=5V and Z= 120Ω) 90 mA MAX (VDC=28V and Z= 1,2kΩ)
Phase displacement	90° ±5° electrical
Vibration resistance (EN60068-2-6)	300 m/s <sup>2</sup> [55 ÷ 2000 Hz]
Shock resistance (EN 60068-2-27)	1000 m/s <sup>2</sup> [11 ms]
Protection class (EN 60529)	IP67
Operating temperature	0°C to +50°C
Storage temperature	-20 to +80°C
Relative humidity	100%
Weight	40 g
Electrical protections	inversion of polarity and short circuits

MSH	
Pole pitch	1+1 mm
Resolution	0.5, 1, 5, 10 µm
Accuracy	±6 µm
Reference indexes	constant pitch every 1 mm
Max. traversing speed	up to 6 m/s

MSM	
Pole pitch	2+2 mm
Resolution	1, 5, 10, 25, 50, 100, 500 and 1000 µm
Accuracy	±8 µm (1, 5, 10, 25, 50 µm) ±10 µm (100 µm) ±8 µm (500, 1000 µm)
Reference indexes	constant pitch every 2 mm external positioned on magnetic band
Max. traversing speed	up to 12 m/s

MSL	
Pole pitch	5+5 mm
Resolution	5, 10, 25, 50 and 100 µm
Accuracy	±30 µm (5, 10, 25, 50 µm) ±50 µm (100 µm)
Reference indexes	constant pitch every 5 mm external positioned on magnetic band
Max. traversing speed	up to 30 m/s

**13. TECHNICAL FEATURES - BAND**

GENERAL FEATURES	
Width	10 mm
Thickness	1.3 mm
Thermal expansion	10,5 x 10 <sup>-6</sup> °C <sup>-1</sup> Tref: 20°C ± 0,1°C
Bending radius	≥ 130 mm
Max. length	50 m
Operating temperature	0°C to +70°C
Storage temperature	-20 to +80°C
Magnetic band weight	65 g/m
Cover weight	25 g/m

CSH	
Pole pitch	1+1 mm
Accuracy at 20°C	±30 µm/meter

CSM / CSMZ	
Pole pitch	2+2 mm
Accuracy at 20°C	±30 µm/meter
Reference indexes CSMZ	positioned upon request, from left or right, at pitches of 4 mm or multiples

CSL / CSLZ	
Pole pitch	5+5 mm
Accuracy at 20°C	±30 µm/meter
Reference indexes CSLZ	positioned upon request, from left or right, at pitches of 10 mm or multiples

**i** Without prior notice, the products may be subject to modifications that the Manufacturer reserves to introduce as deemed necessary for their improvement.