

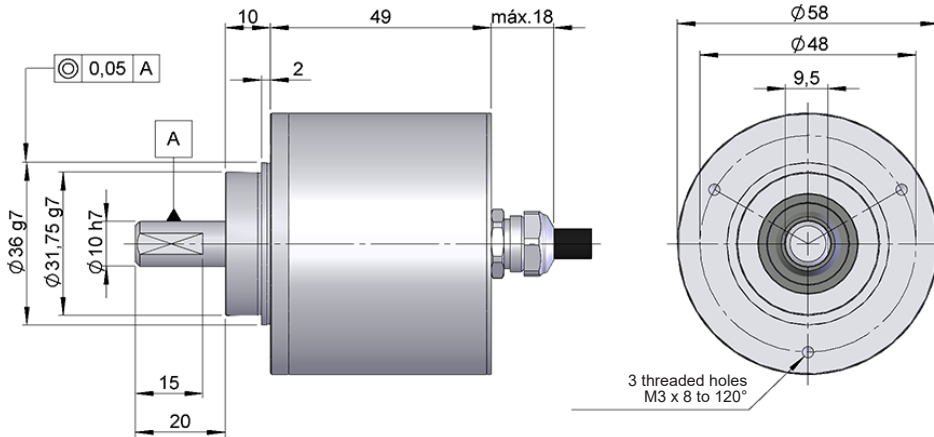

# SERIE 10I INOX

HIGH RESOLUTION INCREMENTAL SOLID SHAFT ENCODER FOR HEAVY DUTY INDUSTRIAL APPLICATIONS

- Resolution up to 50.000 pulses per turn
- External diameter 58 mm
- Shaft  $\varnothing$  10 mm
- Protection class IP67 according to DIN EN 60529
- Executions mechanical, electronic and special optics forms available on request
- Connection by cable (other cable length available)



Drawing shaft type 1, connection type 8, without flange

## REFERENCE

Reference example: 10I-11689-1024

Serie	Shaft	Flange	Output signals	Connection	Power Supply / Electronic output	Pulses number	Special customer
<b>10I -</b>	<input type="checkbox"/>	<input type="checkbox"/>	<input type="checkbox"/>	<input type="checkbox"/>	<input type="checkbox"/>	<input type="checkbox"/> <input type="checkbox"/> <input type="checkbox"/> <input type="checkbox"/> <input type="checkbox"/> <input type="checkbox"/>	<input type="checkbox"/> <input type="checkbox"/> <input type="checkbox"/> <input type="checkbox"/> <input type="checkbox"/> <input type="checkbox"/>
10. Stainless Steel	1. $\varnothing$ 10x20 mm	1. None	1. A 2. A+B 3. A+B+ $\tilde{0}$ 5. A $\tilde{A}$ +B $\tilde{B}$ 6. A $\tilde{A}$ +B $\tilde{B}$ +0 $\tilde{0}$ 9. A+B+0	8. Axial cable	0. 11...30 VDC / NPN Open collector 11...30 VDC 6. 11...30 VDC / RS422 5 VDC (compatible TTL) 7. 5 VDC / RS422 5 VDC (compatible TTL) 9. 11...30 VDC / Line driver differential Push-Pull 11...30 VDC	(*)	AT00. -40°C

Order your reference  
Step file 3D

[info@encoderhohner.com](mailto:info@encoderhohner.com)

service available in 24 h

(\*) 10.000 to 50.000 pulses with interpolation. Available 10.000 direct optical pulses without interpolating upon request.



# SERIE 10I INOX

## HIGH RESOLUTION INCREMENTAL SOLID SHAFT ENCODER FOR HEAVY DUTY INDUSTRIAL APPLICATIONS

### MECHANICAL SPECIFICATIONS

Materials	Cover: Stainless Steel AISI304 Housing: Stainless Steel AISI304 Shaft: Stainless Steel AISI304
Bearings	Ballraces
Bearings lifetime	1x10 <sup>10</sup> rev.
Maximum number of revolutions permitted mechanically	6000 rpm
Protection against dust and splashes according to DIN EN 60529	IP67
Rotor inertia moment	30 gcm <sup>2</sup>
Starting torque at 20°C (68°F)	≤ 0,02 Nm
Maximum load permitted on axial shaft	40 N
Maximum load permitted on radial shaft	80 N
Weight aprox.	0,5 Kg
Operating temperature range	-20°C to +80°C - Standard -40°C to +80°C - Special Customer AT00
Vibration according to DIN EN 60068-2-6	100 m/s <sup>2</sup> (10Hz...2000Hz)
Shock according to DIN EN 60068-2-27	1000 m/s <sup>2</sup> (6ms)
Maximum pulses per turn	50.000
Axial connection	2 meters cable (other cable lengths available or connector mounted at the end of the cable, upon request)

### OUTPUT SIGNALS

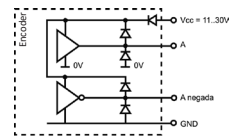
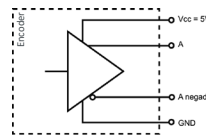
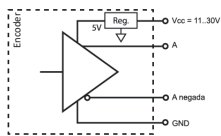
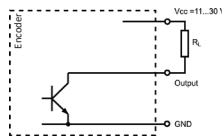

OUTPUT CIRCUIT	NPN Open Collector	RS422 (TTL compatible)	RS422 (TTL compatible)	Push-Pull Differential
Reference code	0	6	7	9
Power supply	11...30 VDC	11...30 VDC	5 VDC ±5%	11...30 VDC
Output voltage	11...30 VDC	5 VDC	5 VDC	11...30 VDC
Consumption	40 mA	Typical: 80 mA Max: 160 mA	Typical: 70 mA Max: 150 mA	Typical: 45 mA Max: 150 mA
Max. load capability / channel	40 mA	±20 mA	±20 mA	±30 mA
Length of cable allowed	50 m (24 VDC)	1200 m	1200 m	100 m
"Low" signal level	VOL < 0.4 VDC (24 VDC)	VOL < 0.5 VDC	VOL < 0.5 VDC	VOL < 2.5 VDC
"High" signal level	VOH > 22 VDC (24 VDC)	VOH > 2.5 VDC	VOH > 2.5 VDC	VOH > VCC – 3 VDC
Frequency	100 kHz	300 kHz	300 kHz	200 kHz
Short circuit protection	Not permanent	Yes	Yes	Yes
Protection polarity inversion	Yes	Yes	No	Yes

Channel B leads (90° electric) channel A, view from the shaft, shaft rotating clockwise

# SERIE 10I INOX

HIGH RESOLUTION INCREMENTAL SOLID SHAFT ENCODER FOR HEAVY DUTY INDUSTRIAL APPLICATIONS

## CONNECTION



	Cable 2x2x0,14+1x0,14 95.0008002	Cable 3x2x0,14+2x0,34 95.0008003 (*)
GND	Yellow	Black
VCC	White	Red
A	Brown	Yellow
B	Green	Green
$\tilde{A}$		Brown
$\tilde{B}$		Blue
0 (reference)	Grey	Grey
$\tilde{0}$	Grey	Orange

(\*) Cable 3x2x0,14+2x0,34 only for encoders with inverted signals.

## ACCESSORIES EXAMPLES

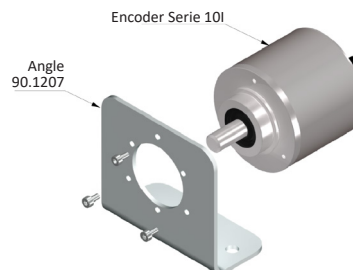
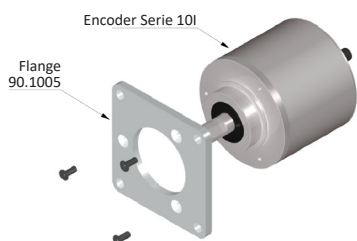

All the accessories available in the section "MOUNTING ACCESSORIES".